

-----DC SUPPLY-----

-----LVDS to CMOS

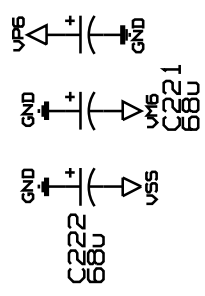

M16  
DS26LS32CM  
SOIC  
VCC=GND; GND=VSS

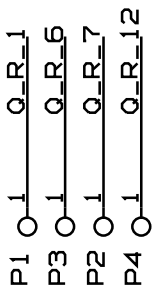
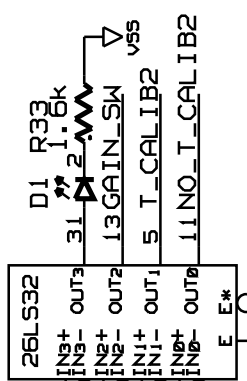

ADDRESS  
ADDRESS  
GAIN\_SW  
GAIN\_SW  
TCALIB2+  
TCALIB2-

M27  
SN74ALS133D  
SOIC  
GND=VSS ; VCC=GND  
AL5133 O9OUT\_NAND

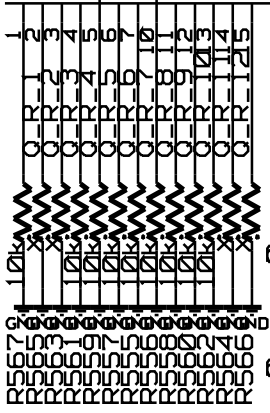

GND=SHIELDING  
J1

----- SCSI connector-----

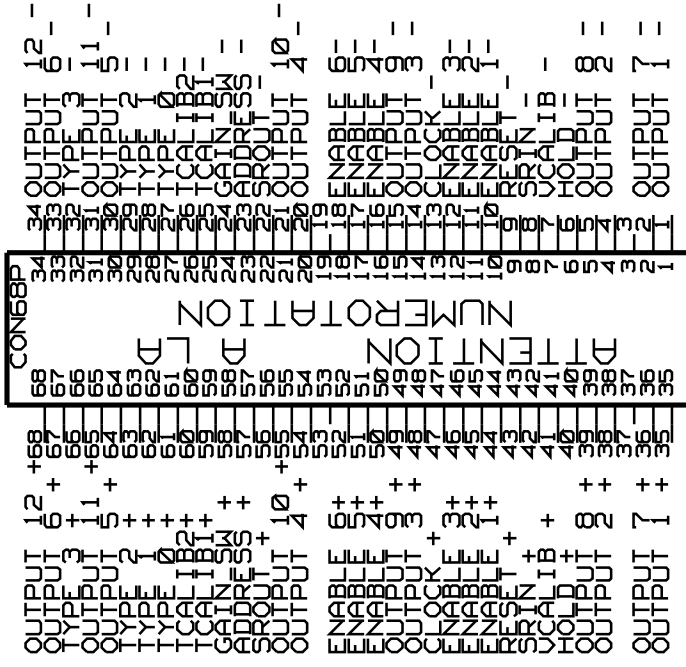

M15  
VCC=VP6  
SOIC  
DS26LS31CM

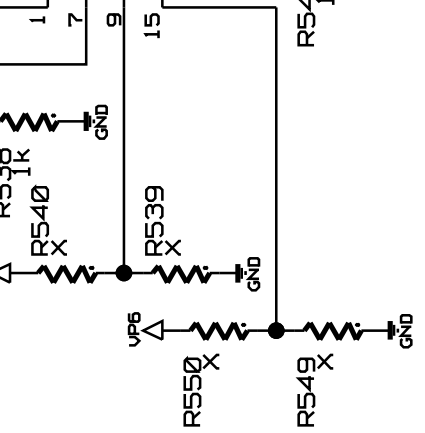
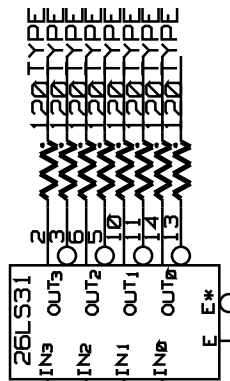

----- TYPE IN