

REVISIONS			
REV	DESCRIPTION	DATE	APPROVED

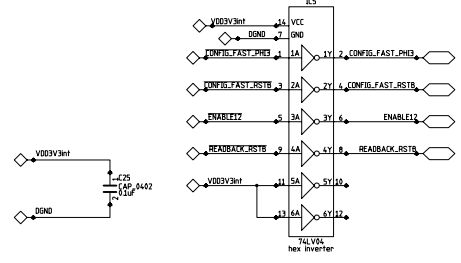
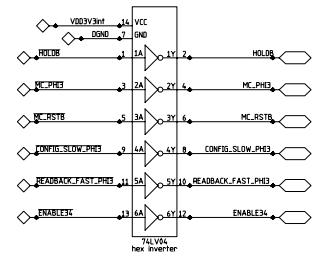
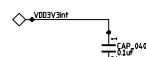
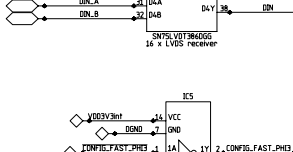
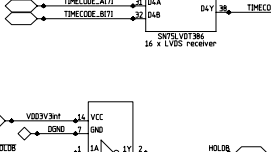
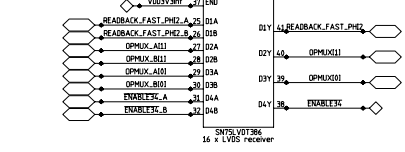
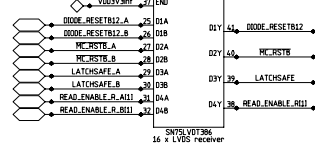
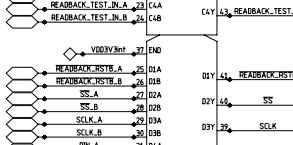
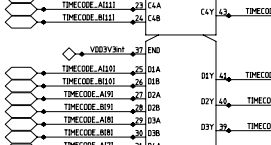
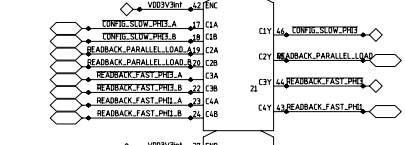
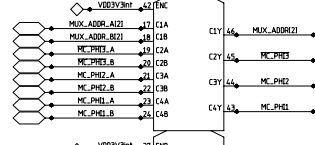
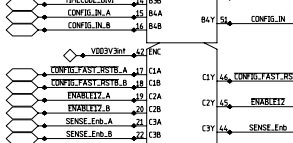
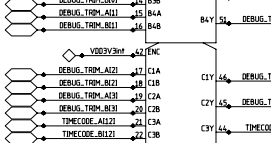
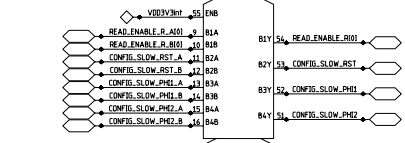
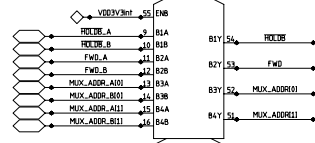
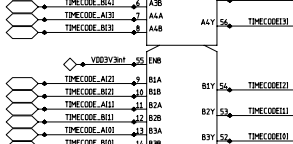
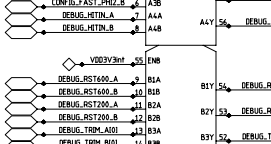
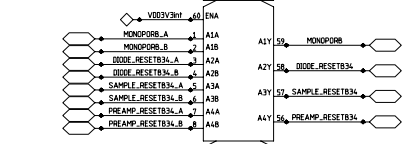
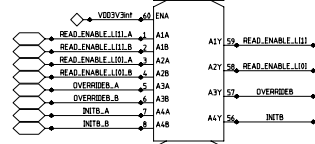
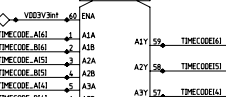
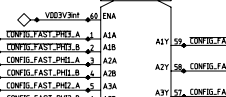
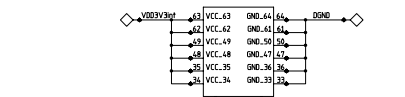
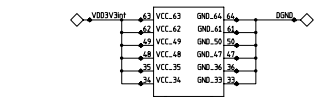
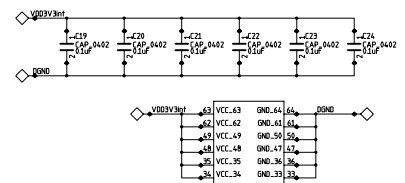
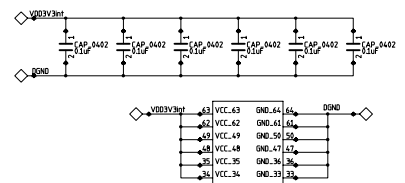
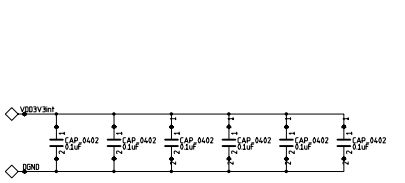
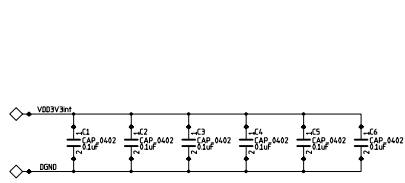

CONTRACT NO.			
APPROVALS	DATE		
DRAWN			
CHECKED			
ISSUED		SHEET	
		SCALE	

LVDS receivers

REV		REVISIONS		DATE	APPROVED

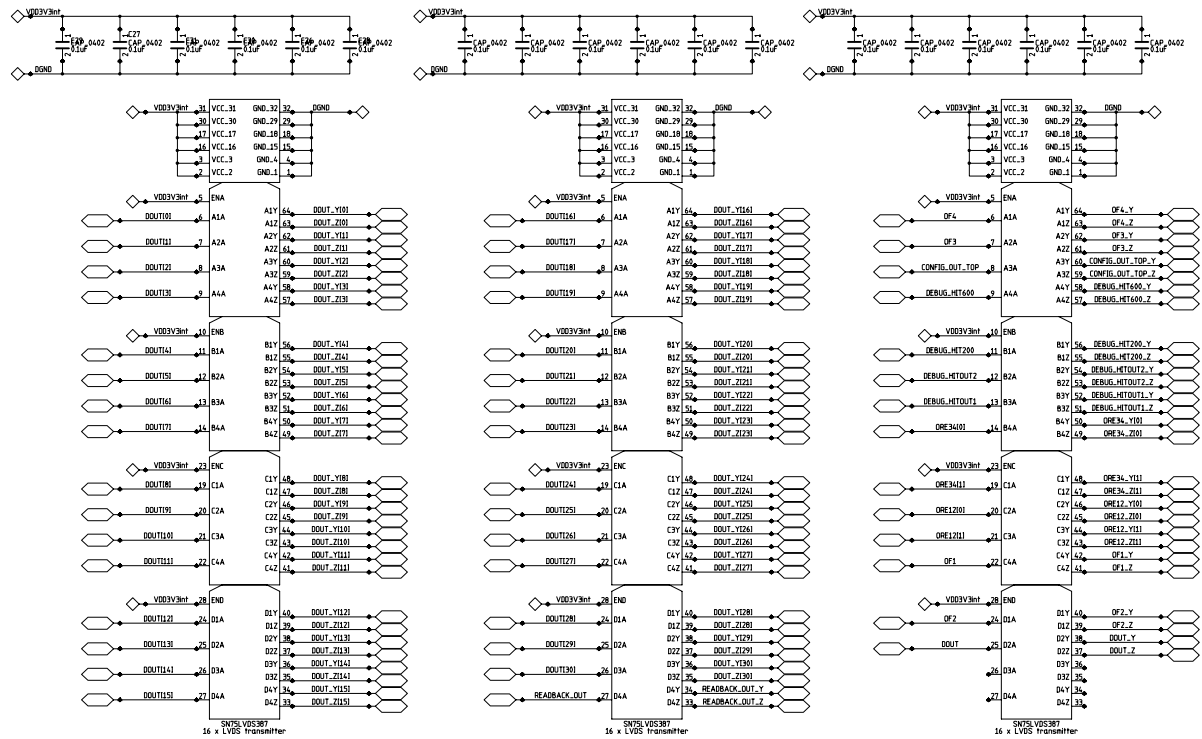

CONTRACT NO.		DATE		LVDS transmitters	REV
APPROVALS					
DRAWN					
CHECKED					
ISSUED		SIZE/FSCM NO.	DWG. NO.		
		SCALE			SHEET

REVISIONS			
REV	DESCRIPTION	DATE	APPROVED

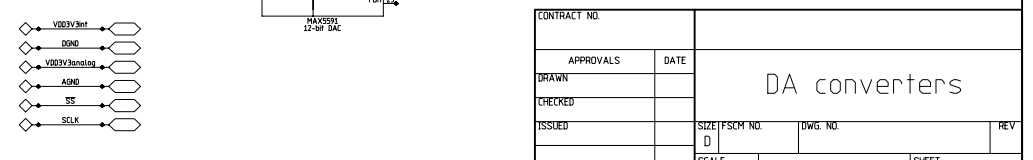
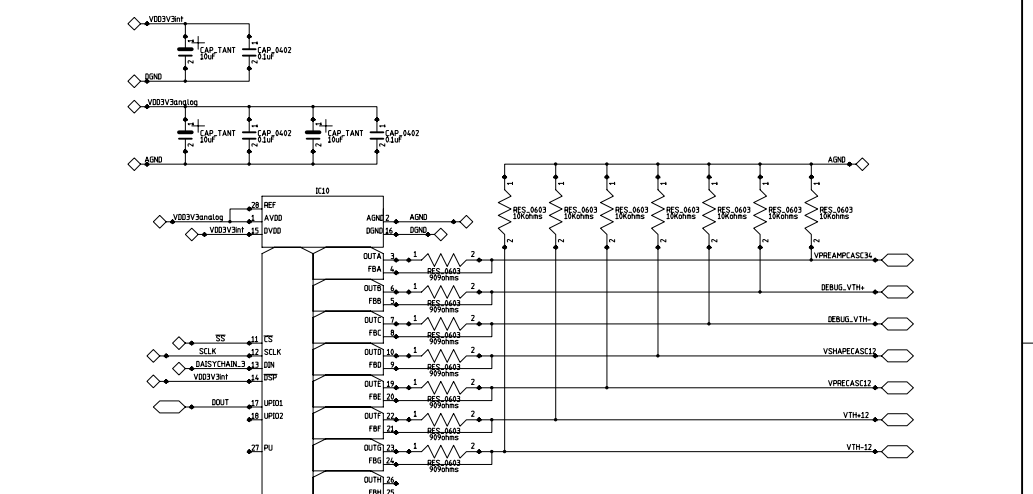
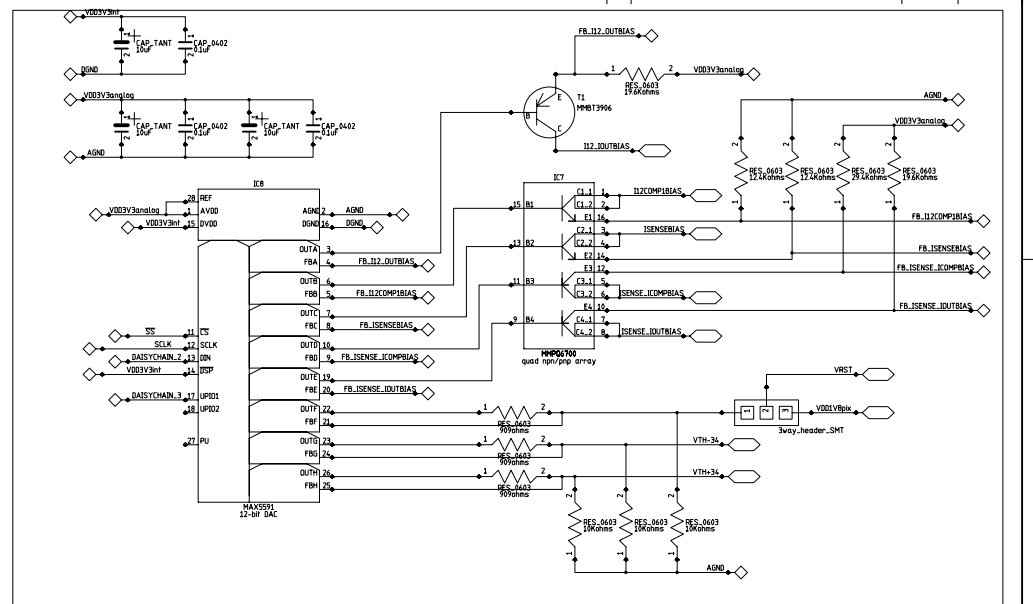

CONTRACT NO.		DATE	
APPROVALS		DATE	
DRAWN		DATE	
CHECKED		DATE	
ISSUED		DATE	
SIZE	FSCM NO.	UWG NO.	REV
SCALE			SHEET

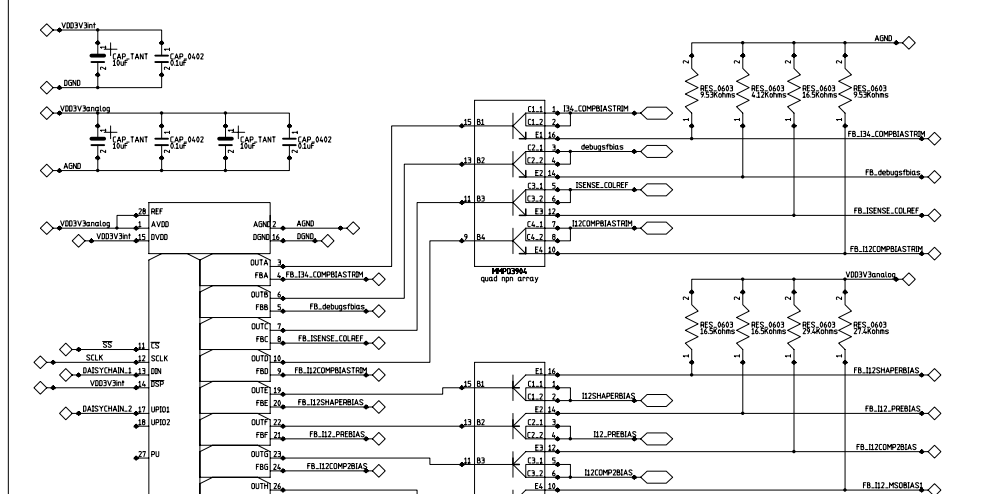
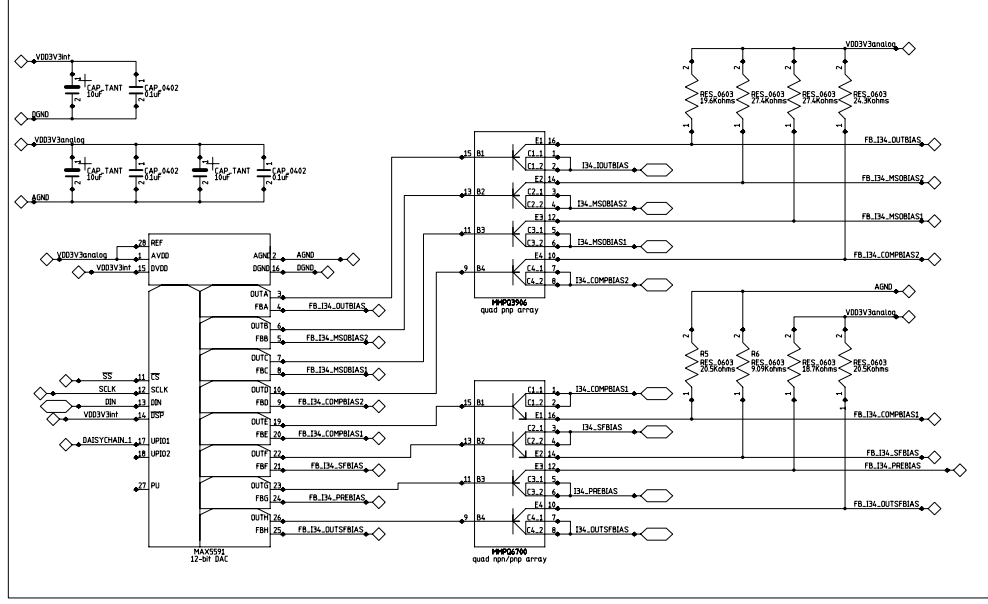

DWG. NO.		SH.	REV.	1
REVISIONS				
REV.	DESCRIPTION	DATE	APPROVED	

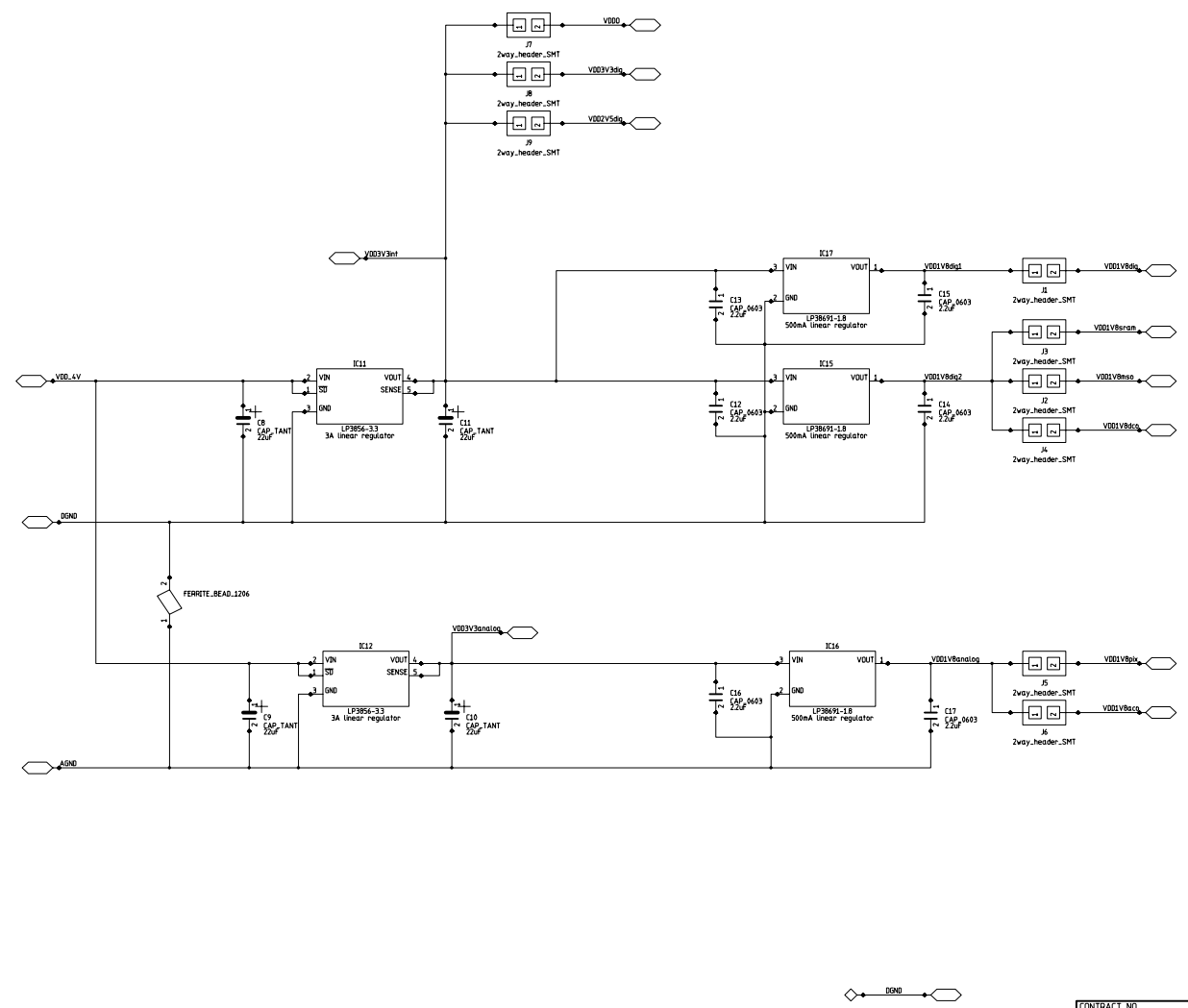

CONTRACT NO.				
APPROVALS	DATE	Power Supply		
DRAWN				
CHECKED				
ISSUED				
		SIZE/FSCM NO.	DWG. NO.	REV.
		SCALE		SHEET

REVISIONS			
REV	DESCRIPTION	DATE	APPROVED

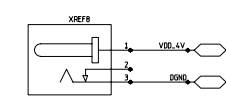
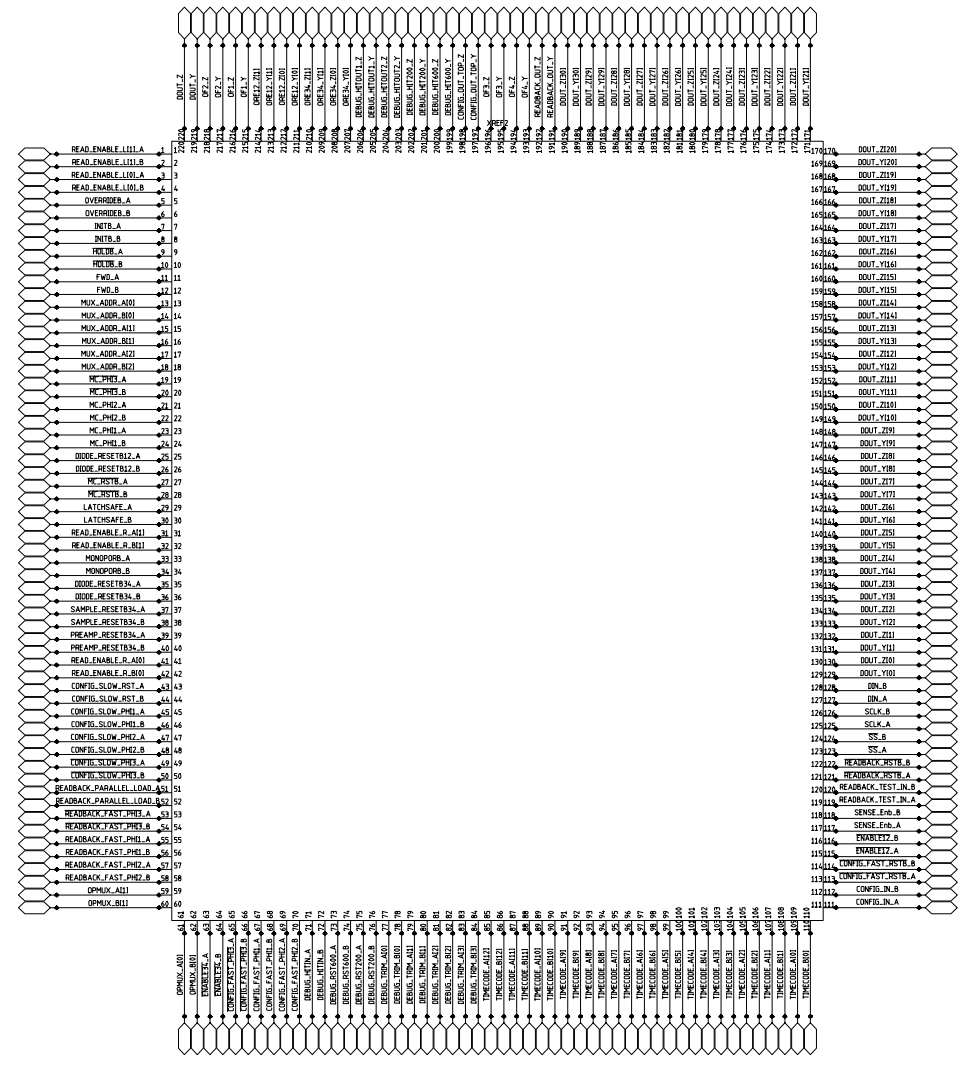

CONTRACT NO.		DATE		Connectors	
APPROVALS					
DRAWN					
CHECKED					
ISSUED		SIZE/FSCM NO.	DWG. NO.	REV	
		SCALE		SHEET	

REV		DESCRIPTION		DATE	APPROVED

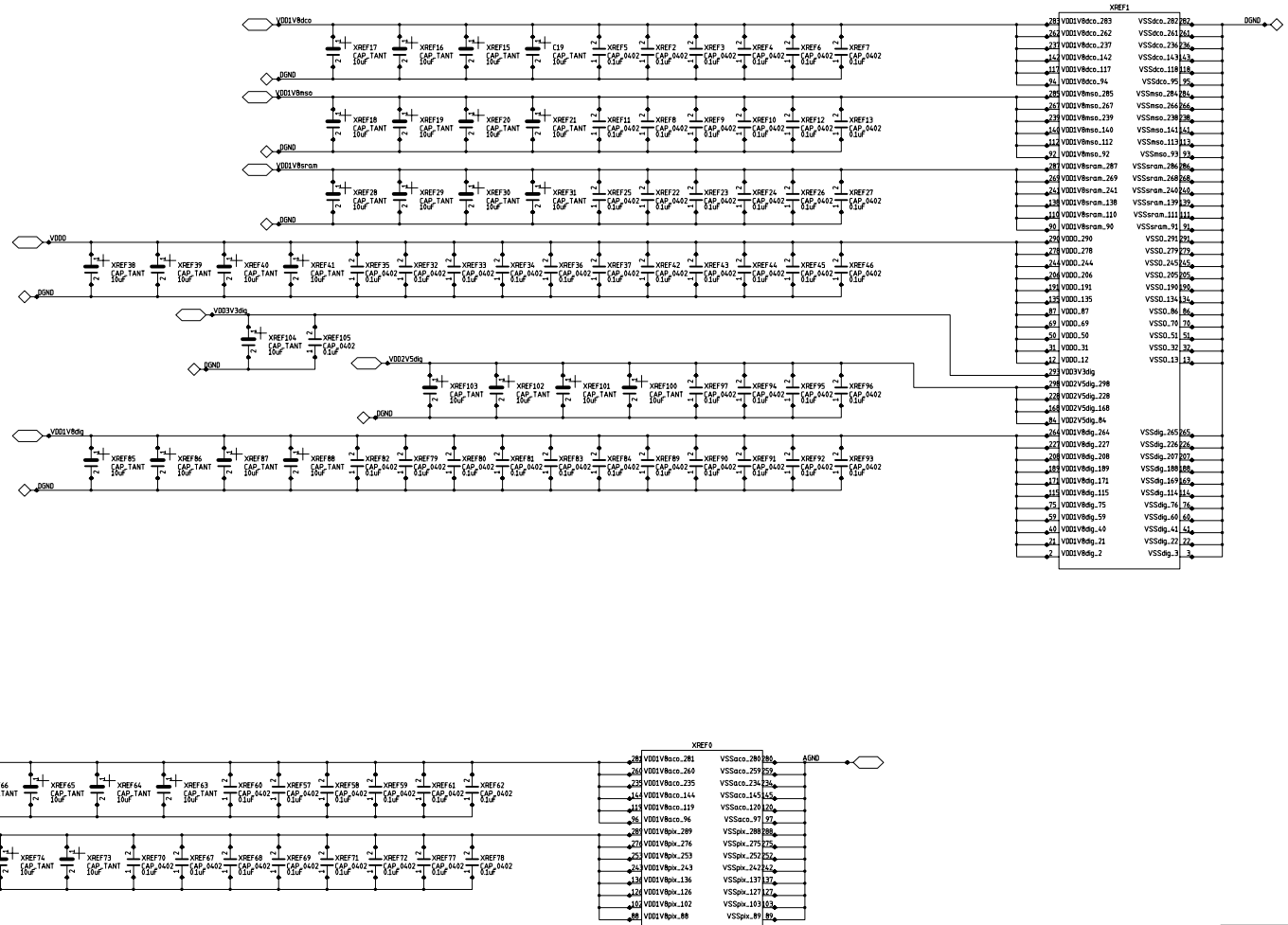

CONTRACT NO.		DATE		Sensor: Power	
APPROVALS		DATE			
DRAWN					
CHECKED					
ISSUED		SIZE/FSCM NO.	DWG. NO.	REV	
		SCALE	SHEET		