

# First Results on the Performance of the CMS Global Calorimeter Trigger

C. Foudas<sup>a</sup>, G. Iles<sup>a</sup>, J. Jones<sup>1a</sup>, A. Rose<sup>a</sup>, M. Stettler<sup>a</sup>, G. Sidiropoulos<sup>a</sup>, A. Tapper<sup>a</sup>,  
J. Brooke<sup>b</sup>, R. Frazier<sup>b</sup>, G. Heath<sup>b</sup>,  
M. Hansen<sup>c</sup>

<sup>a</sup>Imperial College London, UK

<sup>b</sup>Bristol University, UK

<sup>c</sup>CERN, Switzerland

[c.foudas@imperial.ac.uk](mailto:c.foudas@imperial.ac.uk)

## Abstract

The CMS Global Calorimeter Trigger (GCT) uses data from the CMS calorimeters to compute a number kinematical quantities which characterize the LHC event. The GTC output is used by the Global Trigger (GT) along with data from the Global Muon Trigger (GMT) to produce the Level-1 Accept (L1A) decision. The design for the current GCT system commenced early in 2006. After a rapid development phase all the different GCT components have been produced and a large fraction of them have been installed at the CMS electronics cavern (USC-55). There the GCT system has been under test since March 2007. This paper reports results from tests which took place at the USC-55. Initial tests aimed to test the integrity of the GCT data and establish that the proper synchronization had been achieved both internally within GCT as well as with the Regional Calorimeter Trigger (RCT) which provides the GCT input data and with GT which receives the GCT results. After synchronization and data integrity had been established, Monte Carlo Events with electrons in the final state were injected at the GCT inputs and were propagated to the GCT outputs. The GCT output was compared with the predictions of the GCT emulator model in the CMS Monte Carlo and were found to be identical.

## I. INTRODUCTION

GCT is the final stage of the calorimeter trigger chain [1]. The tasks of the GCT in the CMS calorimeter trigger system are:

### A. The Electron Trigger

GCT receives data for 4 isolated and 4 non-isolated electron candidates from each of the 18 RCT crates and sorts them according to their rank which currently has been programmed to be the electron transverse energy. The 4 highest rank candidates of each kind are transmitted to the Global Trigger. The electron rank is 6-bit quantity, the pseudorapidity,  $\eta$ , is a 3-bit quantity and the azimuthal angle,  $\phi$ , is a 5 bit quantity.

### B. The Jet Triggers

Each of the 18 RCT crates covers either the positive or the negative  $\eta$  region and 0.35 units in  $\phi$ . The detector signals from each RCT crate are grouped in 14 regions each containing 4x4 trigger towers. Trigger towers are the smallest granularity regions in the detector that the trigger system can distinguish. In the barrel electromagnetic calorimeter trigger towers are associated with groups of 5x5 crystals, whose surface perpendicular to the radial direction is approximately 2.2x2.2cm<sup>2</sup>.

RCT computes the transverse energy for each region along with a  $\tau$ -veto bit which indicates that the energy deposited in a given region is not collimated enough to originate from  $\tau$ -lepton hadronic decay. The regional data are transmitted to GCT which searches for jets using a 3x3 region window. An object is defined to be a jet by requiring that the central region in the window has greater or equal transverse energy than the surrounding regions and that the total transverse energy within the window is larger than a programmable cut. Jets are classified as central and forward based on a programmable  $\eta$  cut. A third category of jets, the  $\tau$ -jets, is formed by the jets where the  $\tau$ -veto bit is not set in any of the 3x3 regions which form the jet. After completing the jet search, GCT transmits to GT the 4 highest transverse energy jets from each of the three categories. The jet transverse energy is a 6-bit quantity, the jet- $\eta$ , is a 3-bit quantity and the jet- $\phi$ , is a 5 bit quantity.

### C. Total Jet Transverse Energy and Jet Counters

The Total Jet Transverse Energy,  $H_t$ , is computed during the jet search. All jets found contribute in calculating  $H_t$ . Hence,  $H_t$  includes information from the jets which may be present in the event but have jet transverse energy smaller than the four that are transmitted to GT.  $H_t$  is transmitted as a 12 bit quantity plus an overflow bit.

It has been foreseen that GCT will be able to transmit to GT 12 different 5-bit jet counters. The algorithms for this have not yet been specified. However, the nature of the counter data is fully programmable in the GCT firmware. Hence, there is a total of 60 uncommitted bits which are transmitted to GT and represent the contingency of the GCT system for future new algorithms including jet counters.

<sup>1</sup> Currently at Physics Department, University of Princeton, Princeton, New Jersey, USA.

### D. Total Transverse Energy

The Total Transverse energy,  $E_t$ , is computed from the RCT regional data and includes all calorimeter energy depositions of the event.  $E_t$  is a 12 bit quantity and an overflow bit has been assigned to it

### E. Total Missing Transverse Energy

The Total Missing Transverse Energy,  $E_{\text{mis}}$ , is computed from the total x- and y-components of the energy depositions throughout the CMS calorimeter.  $E_{\text{mis}}$  is transmitted as a 12-bit quantity and an overflow bit assigned to it. The  $\phi$ -direction of  $E_{\text{mis}}$  is also computed and transmitted as a 6-bit quantity.

### F. Quiet and MIP Bits

For each of the 14 regions assigned to an RCT crate, RCT transmits 2 extra bits called the Quiet and MIP bits. The Quiet bit indicates that the total energy in a given region is below a programmable threshold. The MIP bit indicates that the energy deposition is consistent with that of a minimum ionizing particle. 504 Quiet and MIP bits are transmitted in total from RCT to GCT which are  $\phi$ -segmented. GCT regroups the data in  $\eta$ -segmentation and transmits them to the Global Muon Trigger where they will provide an additional handle in identifying muons<sup>2</sup>.

### G. RCT Data Readout

GCT has a standard SLINK64 interface with the CMS DAQ system and for every bunch crossing with a L1A it transmits to the DAQ both its input and output data along with intermediate quantities computed by its algorithms. In addition to this it also transmits the same record for the crossings which are before and after the crossing with the L1A to test for possible synchronization failures.

## II. THE GCT HARDWARE ARCHITECTURE

The GCT architecture has been described in [2] and the algorithm implementation in [3]. In this paper we provide a brief summary of the GCT architecture. The GCT architecture has been optimized for finding jets. Jets are collimated collections of particles which are emitted in high energy reactions. However, unlike other objects such as electrons or photons, jets are extended objects and jet-finding requires the combination of data which originate from regions of the calorimeter which are far apart from each other. For example the diameter of a jet in the CMS barrel calorimeter could be as large as 1.2 m. The data need to be concentrated in a small number of processing units. For this reason 1.6 GB/s optical links are used to concentrate the entire calorimeter data in 8 processing units, the Leaf Cards, which execute all algorithms. Optical links provide also for electrically isolating the GCT system from RCT which is located about 12 meters away from the main GCT crate.

<sup>2</sup> This is a trigger that is not foreseen for the first LHC run and its performance is still under study.

Shown in Fig. 1 is the GCT architecture. The 8 Leaf Cards are shown in grey. Two electron Leaf Cards (top/bottom), receive the fibres carrying the electron data (black arrows) and perform the electron candidate sorting for either positive or negative  $\eta$ . Six jet Leaf Cards (left and right) connected in a ring topology execute the jet finder in groups of 3 for positive and negative  $\eta$ .

The electron data are send directly to the Concentrator Card (shown in green) whilst for jet data the Wheel Cards (shown in blue) execute the jet pre-sorting before transmitting the data to the Concentrator Card. The Concentrator Card performs the final sorting for jets and electrons, computes the final energy sums and transmits the data to GT and CMS DAQ.

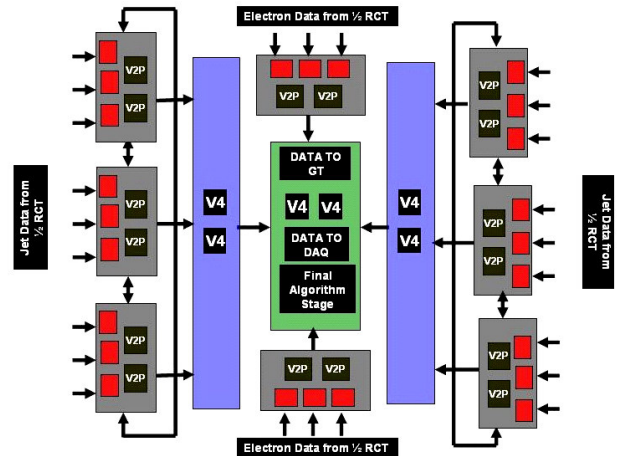
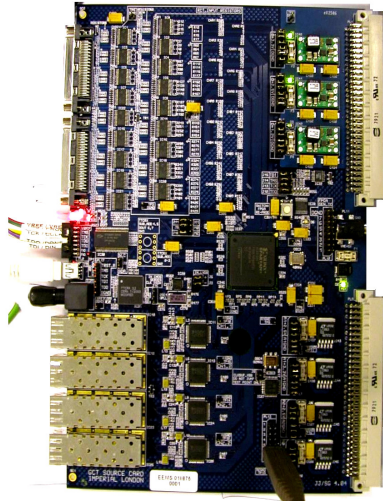

**Figure 1:** The GCT Architecture. Jet and electron related data from RCT are transmitted via 1.6 GB/s optical links, shown as black arrows at the periphery of the picture, to the 8 Leaf Cards, shown in grey, which execute the GCT algorithms. The Wheel Cards, which are shown in blue, and the Concentrator Card which is shown in green, further sort and reduce the data. The Concentrator Card transmits the results to GT.

### A. The Source Cards

The first stage of the GCT consists of 63 6U VME cards, the Source Cards, shown in Fig. 2, whose task is to convert the RCT data from ECL to optical format. 108 Cables transmit the RCT data in 80 MHz ECL format to the Source Cards. Each Source Card receives the data via two VHDCI SCSI connectors. The data is level-shifted and serialized using 4 TLK2501 devices and are converted to optical format using 4 Agilent HFBR-5720AL SFPs. The optical data from the Source Cards are transmitted to the main GCT crate using 12 m fibres and an optical patch panel. There the data are received by the Leaf Cards which are described below. All communications and on board data handling are done using a Xilinx SPARTAN XC23S1000-5FG676C FPGA. A standard TTCRx with a QPLL are used to receive the LHC clock via a

fibre connector at the front panel. For readout and control the Source Cards are equipped with an on board USB-2 interface.



**Figure 2:** The GCT Source Card. The two front panel connectors at the top receive the RCT data. The SPATAN-3 FPGA is seen at the middle of the PCB. JTAG, USB and TTC fibre connectors are seen at the centre of the front panel. The 4 SFPs are shown at the lower part of the front panel. The VME bus is only used to receive power and separate sections for digital an analogue power are seen close to the VME connectors.

The Source Card firmware have been designed to allow several diagnostic capabilities which can be activated for online or offline operation:

During data taking the Source Cards monitor continuously the BX0 signals coming along with the RCT data with those coming from the central TTC system. Any phase change between the two will cause a synchronization error. CRC codes are used to test the integrity of the optical data transmission. RCT channels which suffer data corruption can be turned off at the Source Card level using USB commands. The on-board temperatures are constantly monitored via USB.

During offline testing the source Cards can capture up to 2048 RCT events and read them out via USB. This feature is used extensively to test the RCT system. Alternatively using USB one can up-load up to 2048 events in the Source Card buffers and transmit them to the Leaf Cards. This feature has been used to test the performance of GCT. The buffers can be loaded with arbitrary test patterns as well as entire Monte Carlo events.

### B. The Leaf Cards

Shown in Fig. 3 is the Leaf Card which is the main processor card of the GCT system. Two versions of the Leaf Card exist depending upon the firmware that is uploaded to the card: The Electron Leaf cards which execute electron trigger related algorithms and the jet Leaf Cards which execute all the jet related algorithms including the calculations of,  $E_t$ ,  $E_{mis}$ ,  $H_t$ . Since the original design, more

features have been added to the jet Leaf Card firmware for use during the first LHC data run: The jet Leaf Cards compute the total transverse energy and the number of towers-over-energy-threshold for two rings around the CMS beam pipe. These quantities are intended for providing a beam activity trigger in the forward regions of the detector.

The Leaf Cards receive the data which come from the Source Cards in optical format using 3 SNAP12 devices each capable of receiving 12 fibres. 32 of these channels have been routed to the Multi Gigabit Transceivers (MGTs) of two Virtex-II Pro P70 FPGAs each equipped with 16 MGTs.

The two electron Leaf Cards are mounted using PMC connectors directly on the Concentrator Card which is described below. In this mode they receive all isolated and non-isolated electron candidates from the Source Cards and sort them according to their rank. Each electron Leaf Card performs the electron sorting for either positive or negative  $\eta$  candidates and transmits the data from the 4 highest rank electron candidates to the Concentrator Card.

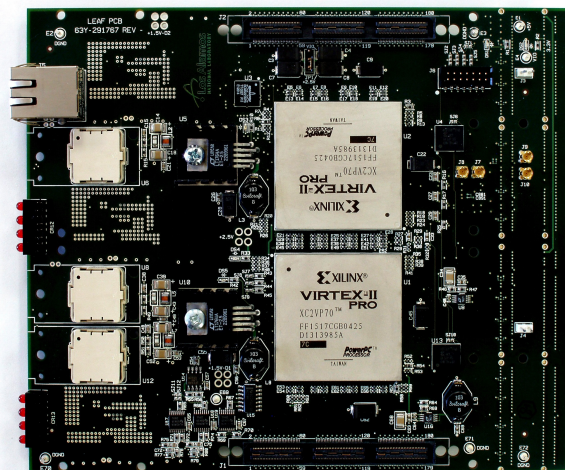

**Figure 3:** The Leaf Card. Shown at the centre are two Virtex-II Pro P70 parts. 3 SNAP 12 connectors (left) receive the data. Two 60 pair connectors are shown at the top and bottom for Leaf-to-Leaf communication. The PMC connector to the right is used to communicate either with the Concentrator Card or the Wheel Card.

As shown in Fig. 1, groups of 3 Leaf Cards are connected in ring configurations to search for jets in half of the CMS calorimeter covering either the positive or the negative  $\eta$ -region as described in section I. The details of the jet finding algorithms have been described in [3].

Two 60 pair connectors provide for the Leaf Card-to-Leaf Card data exchange and each 3-Leaf Card group is mounted via PMC connectors on a Wheel Card which is described below. Data originating from the  $\eta = 0$  region are duplicated by the Source Cards and are sent to both groups of Leaf Cards. This way no data exchange is required between the two 3-Leaf Card groups. Each Leaf Card transmits the jets found to the Wheel Card.

### C. The Wheel Cards

Seen in Fig. 4 is the Wheel Card. The Wheel Card PCB has 9U 400 mm VME format. However, it uses the VME bus only for power. Three jet Leaf Cards mount via PMC connectors on both sides of the Wheel Card and transmit their jet data to the Wheel Card. The Leaf Cards on the Wheel are connected in a ring configuration via the Leaf 60-pair Samtec connectors using flat cables. For this reason, as shown in Fig. 4, the Wheel Card PCB does not cover the entire 9U space at the place that the Leafs are mounted.

The Wheel Card does the first sorting of the jet data and collects all  $E_t$ ,  $E_{\text{mis}}$ ,  $H_t$  and ring sums from the Leafs to form the overall detector positive and negative  $\eta$  sums. Two Virtex-4 LX100 parts called the jet and energy FPGAs are used separately for processing the jet and energy quantities.

The Wheel Cards transmit the data from the 4 highest rank jets of each kind and the transverse energy and ring sums to the Concentrator Card via 3 flat Samtec cables whose connectors are shown at the back region of the PCB. The Wheel Card lacks a VME interface and communicates with VME via the Concentrator Card.

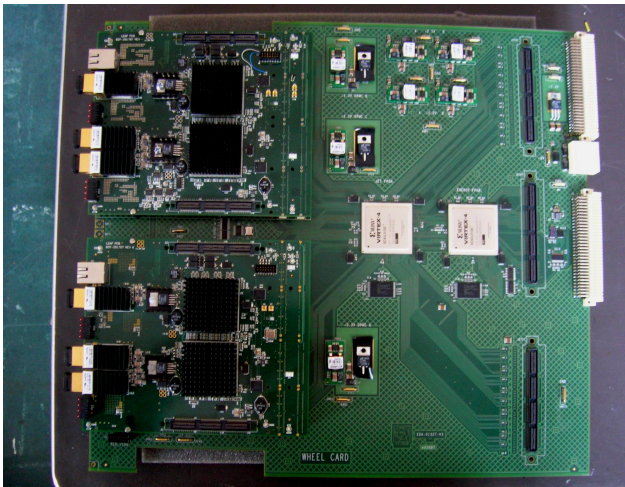

**Figure 4:** The Wheel Card: Two Jets Leafs are shown to be mounted on the component side of the Wheel Card using PMC connectors. A third Leaf Card, not seen here, is mounted on the reverse side of the PCB. Two Virtex-4 parts are shown at the centre of the card. Three Samtec connectors used for transmitting data to the Concentrator Card are shown at the back region of the PCB.

### D. The Concentrator Card

The Concentrator Card is a 9U 400 mm VME card which collects all data from the two Wheel Cards and the two electron Leaf Cards and performs the final sorting of jets and electrons and the final calculations for  $E_t$ ,  $E_{\text{mis}}$ ,  $H_t$  and ring sums. All calculations are handled by two Virtex-4 LX100

parts, the energy and jet FPGAs, whose design is similar with the Wheel Card.

The Concentrator receives clock and control via a standard TTCRx interface. Communications with GT are handled by the Global Trigger Interface Card (GTI) which mounts as PMC card at the lower front side of the Concentrator Card PCB. Two Electron Leaf Cards mount on the top front side of the Concentrator Card PCB from both sides and two Wheel cards are connected with the Concentrator Card via 3 Samtec flat cable connectors on both sides of the Concentrator Card. A Virtex-II 3000 FPGA handles all VME and SLINK64 Communications.

The Concentrator Card used its VME interface for control and slow readout intended for troubleshooting. The SLINK64 interface is used to send the data to the CMS DAQ as described in Section I, task- G.

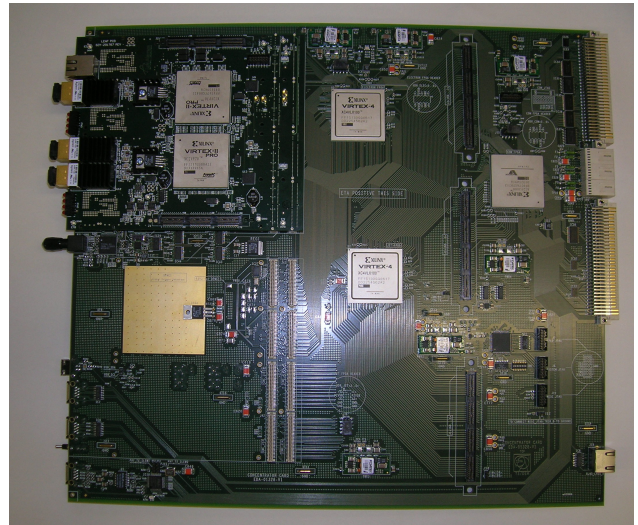

**Figure 5:** The Concentrator Card. An electron Leaf Card is shown mounted in the upper left section. The TTC fibre connector is shown directly below the Leaf Card. The GTI card is mounted at the lower left PMC space. Two V4 LX100 parts are shown at the centre and a V2 3000 part in the upper right side. The J2 VME connector is used for the SLINK64 interface. The connector to the lower right side transmits fast feedback information to the DAQ including backpressure.

## III. COMMISSIONING OF THE ELECTRON TRIGGER

Late in March 2007 the electron part of GCT was installed in USC-55. This includes 18 Source Cards along with the associated optical fibres and optical patch panel, 2 Leaf Cards and one Concentrator Card. Integration and commissioning activities took place in the period between April 07 and September 07 and results from these activities are presented in the rest of this paper. It is perhaps interesting to the community to mention that for the duration of the installation and commissioning activities the project required full time, two engineers, two physicists and one PhD student.

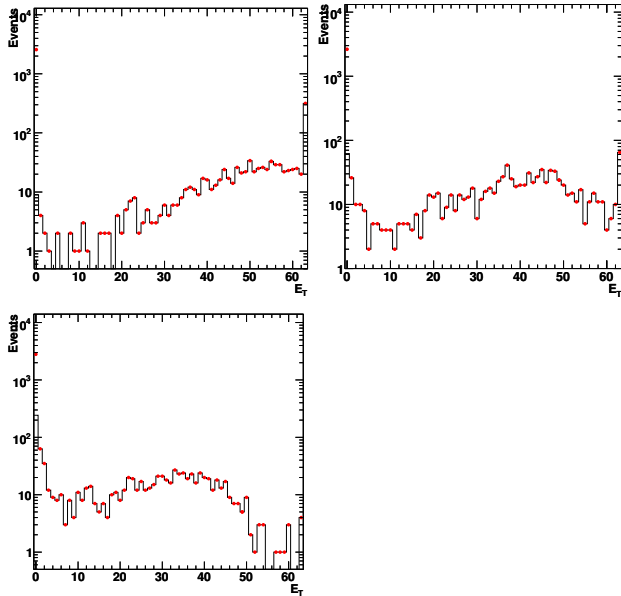

**Figure 6:** GCT processed Monte Carlo events which describe the production of a Standard Model Higgs boson decaying to four electrons (red points) compared with the GCT emulator results (histogram). The plots show the  $E_t$  of the three electrons found, sorted in  $E_t$ , in the range between 0 and 63 (6 bits). The disagreement in the first bin is due to the fact that the 2048 event buffers on the Source Cards have also had empty events mixed with Monte Carlo events to monitor synchronization. The higher  $E_t$  bin contains the overflows which always have an energy of 63 by design.

#### IV. VALIDATION AND PERFORMANCE TESTS

##### A. Simple Electron Pattern Tests

After installation the electron trigger assembly was tested using simple fixed patterns as well as incrementing patterns, the so called counter data.

First data transmission and synchronization was established between the Source Card system and various RCT crates. Several different patterns were transmitted correctly whilst the phase difference between the BX0 from RCT and that from TTC was continuously monitored and found to be stable throughout these tests. Counter data established robust synchronization between RCT and the Source Card system. RCT data was properly captured at the Source Card buffers and readout via USB-2. The USB-2 readout was tested and commissioned.

The same tests were repeated equally successfully by injecting the test patterns into the ECAL and HCAL Trigger Primitive Generators (TPGs) and transmitting them via RCT to the Source Cards.

In the final stage of testing the patterns and counter data were transmitted from the ECAL and HCAL TPGs via RCT and the Source Card system to the GCT crate and the GT. The data were readout at several places of the trigger pipeline:

They were read out via the Concentrator Card VME interface as well as sent to the DAQ via the S-LINK64 interface and were also read out via the GT VME interface. These tests have established that electron data can be transferred correctly without any loss of synchronization over long periods of time.

##### B. Testing with Monte Carlo Events

After being convinced that data could be correctly transmitted through the calorimeter trigger system, Monte Carlo Events were used to test the GCT electron algorithms.

Single electron events as well as Higgs events decaying to 4 electrons were used to test the GCT electron sorting hardware and algorithms. The CMS Trigger Monte Carlo has been modified to produce files that can be injected directly to the 2048 event buffers of the Source Cards. The data were propagated all the way to the Concentrator in a fashion which is identical to the LHC data operations and were captured and ready out by the Concentrator Card VME interface. The results which were computed by the GCT hardware were compared with those computed by the CMS trigger emulator using the same event sample.

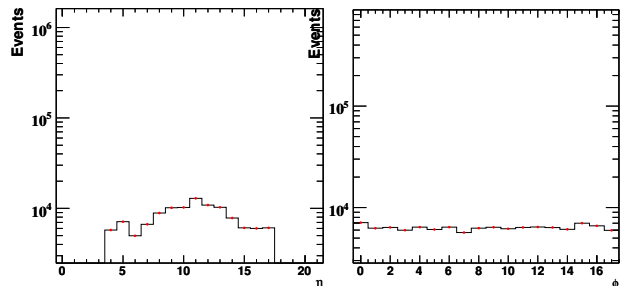

**Figure 7:**  $\eta$  and  $\phi$  distributions of electron candidates as in Fig. 6.

The results of these comparisons are shown in Fig. 6 and 7 and demonstrate complete agreement between the algorithms implemented in the firmware and hardware and those in the CMS Monte Carlo.

#### V. CONCLUSIONS

The CMS GCT electron trigger path has been installed, tested and found to be working as designed. Hence, the GCT electron trigger has been commissioned.

#### VI. REFERENCES

- [1] The Trigger and Data Acquisition Project, Vol. I, The Level-1 Trigger, CERN/LHCC 2000-038, CMS TDR 6.1, 15 December 2000.
- [2] The CMS Global Calorimeter Trigger Hardware Design, M. Stettler et al., Proceedings of the LECC, Valencia, 2006.
- [3] The CMS Global Calorimeter Trigger Hardware Design, G. Revised CMS Global Calorimeter Trigger Algorithms & Functionality, G. Iles et al., Proceedings of the LECC, Valencia, 2006.

